

LOICAS SANITÁRIAS

Lavatório Coluna **LIFE** preto



CODIGO	€
15013102	650,00

Sanita Compacta c/ cisterna mecanismo e tampo SC **LIFE** preto

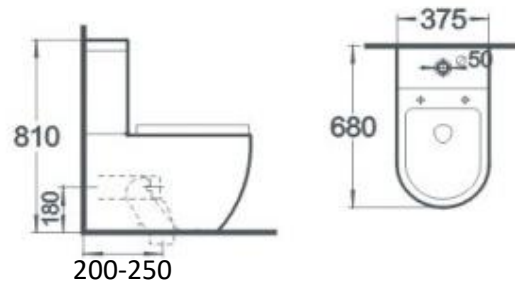

CODIGO	€
15025202	400,00

Sanita suspensa c/ Tampo **LIFE** preto

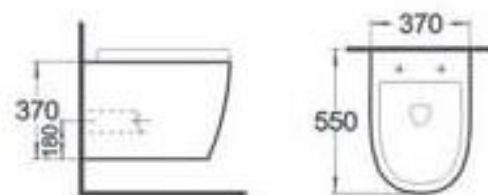

CODIGO	€
15025222	330,00

LOICAS SANITÁRIAS



Sanita Compacta c/ cisterna mecanismo e tampo SC **ELEGANCE**

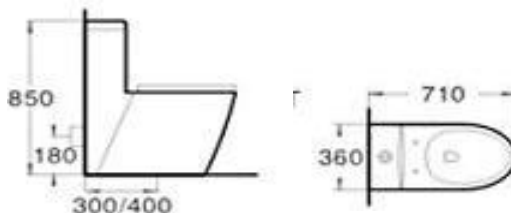

CODIGO	€
15020101	270,00



Bidé **ELEGANCE**



CODIGO	€
15022001	140,00



Sanita Compacta c/ cisterna mecanismo e tampo SC **NAOMI**

CODIGO	€
15013211	210,00



Bidé **NAOMI**

CODIGO	€
15013213	145,00

LOICAS SANITÁRIAS

Sanita Compacta c/ cisterna mecanismo e tampo SC **LOTUS**

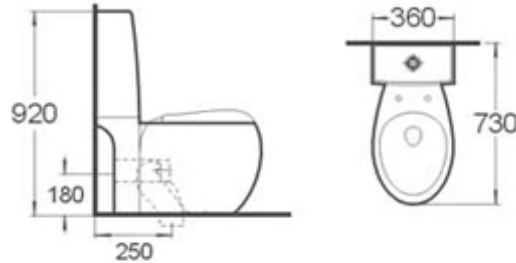

CODIGO	€
15010101	490,00

Bidé **LOTUS**



CODIGO	€
15012001	195,00

Sanita Compacta c/ cisterna mecanismo e tampo SC **LIFE**

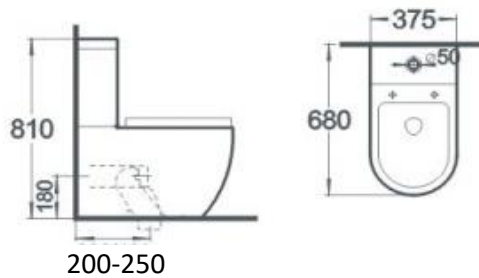

CODIGO	€
15025201	265,00

Bidé **LIFE**



CODIGO	€
15025211	140,00

LOICAS SANITÁRIAS



Sanita Compacta c/ cisterna mecanismo e tampo SC **ART**

CODIGO	€
15013201	210,00



Bidé **ART**

CODIGO	€
15013203	145,00



Sanita Compacta c/ cisterna mecanismo e tampo SC **COROA**

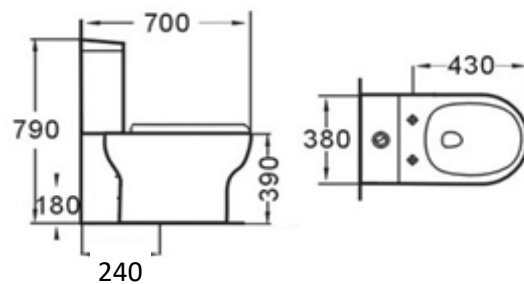

CODIGO	€
15550101	170,00



Bidé **COROA**



CODIGO	€
15552001	120,00

LOICAS SANITÁRIAS



Sanita Compacta c/ cisterna mecanismo e tampo SC **ATLANTIS**

CODIGO	€
15035112	275,00



Bidé **ATLANTIS**

CODIGO	€
15035110	135,00



Sanita Suspensa C/ Tampo Soft Close **COSMOS**

CODIGO	€
15035101	165,00

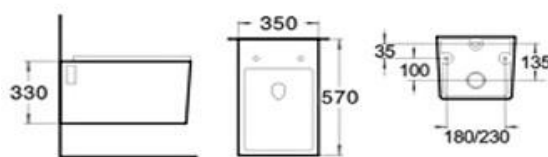

Bidé Suspenso **COSMOS**

CODIGO	€
15035111	140,00

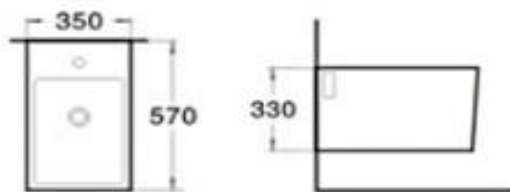

LOICAS SANITÁRIAS

Sanita Suspensa C/ Tampo Soft Close **LIFE**

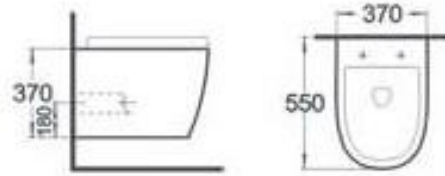

CODIGO	€
15025221	180,00

Bidé Suspenso **LIFE**

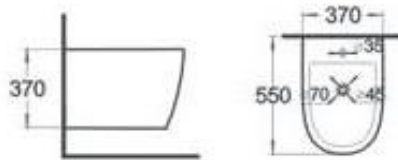

CODIGO	€
15025231	175,00

Sanita Suspensa C/ Tampo Soft Close **LUGO**

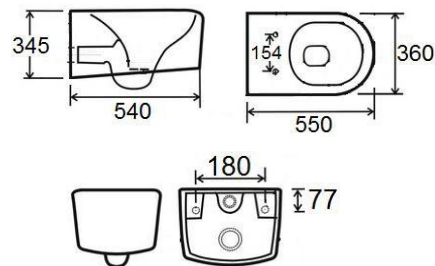

CODIGO	€
15040110	210,00

Bidé Suspenso **LUGO**

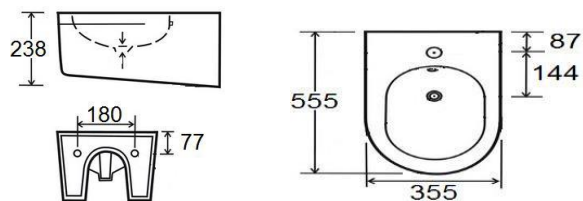

CODIGO	€
15040121	125,00

LOICAS SANITÁRIAS

Sanita Suspensa c/ Tampo Soft Close **LOTUS**

CODIGO	€
15070101	295,00

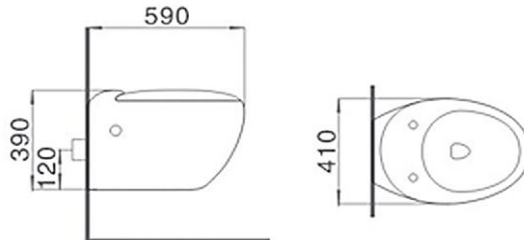

Bidé Suspenso **LOTUS**

CODIGO	€
15072001	195,00

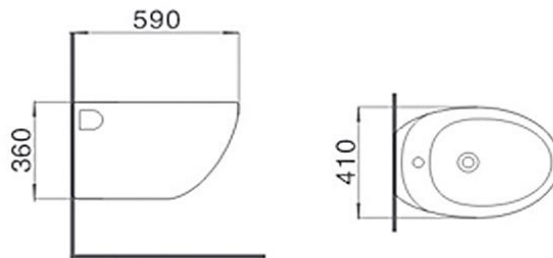

Sanita Suspensa c/ Tampo Soft Close **MONACO**

CODIGO	€
15075101	230,00

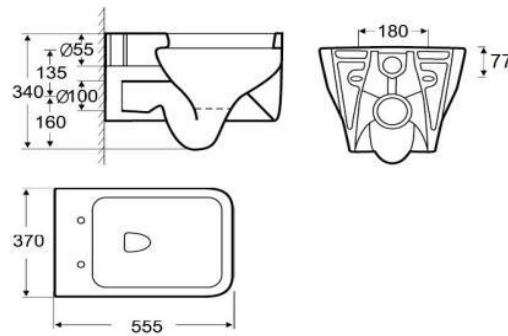

Bidé Suspenso **MONACO**

CODIGO	€
15075111	140,00

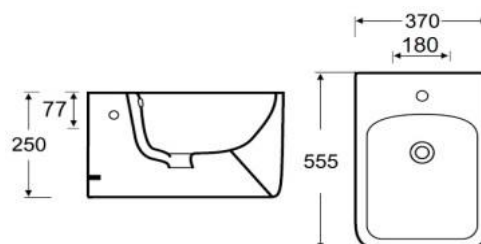

LOICAS SANITÁRIAS

Sanita Suspensa c/tampo soft close

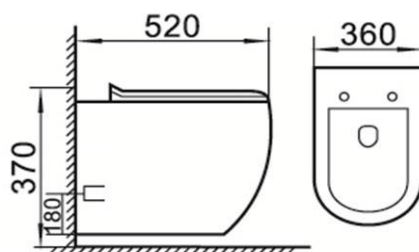

CODIGO	€
15065101	230,00

Sanita Compacta c/ cisterna mecanismo e tampo **OPTIMA**

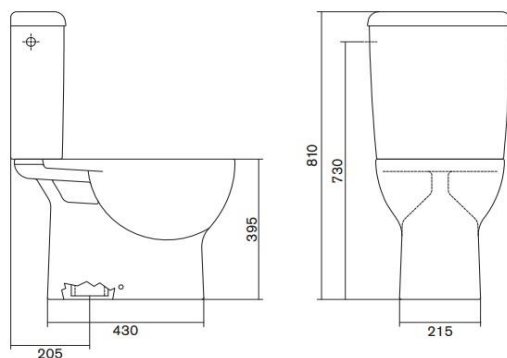

CODIGO	€
15120501*	182,00
15120502#	176,00

*Tampo Dobradiças Inox
#Tampo Dobradiças Nylon

Bidé **OPTIMA**

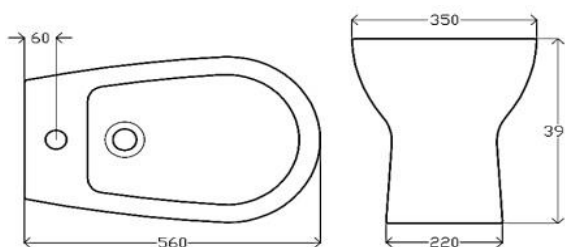

CODIGO	€
15122001	70,00

Lavatorio 50 c/ Coluna **OPTIMA**

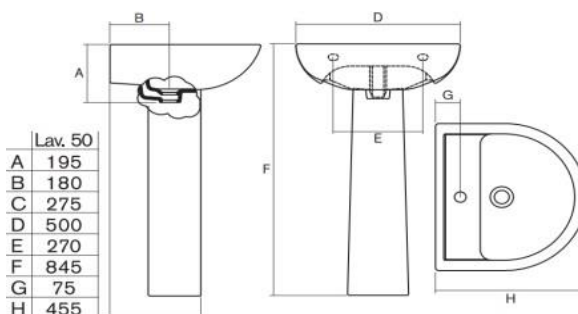

Lav. 50	
A	195
B	180
C	275
D	500
E	270
F	845
G	75
H	455

CODIGO	€
15500501	100,00

LOICAS SANITÁRIAS

Sanita Compacta c/ cisterna mecanismo e tampo **IBIZA**

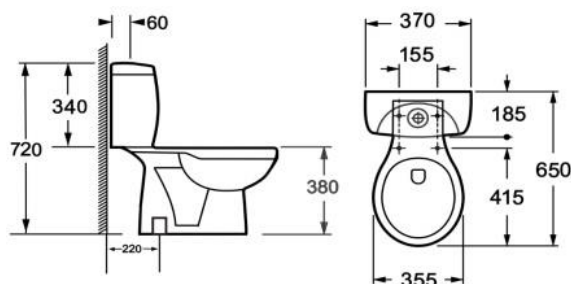

CODIGO	€
15500101	90,00

Bidé **IBIZA**

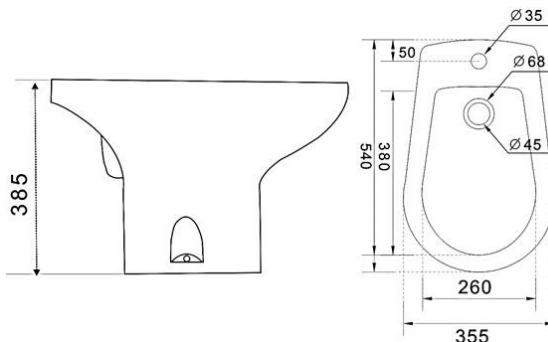

CODIGO	€
15500201	52,00

Lavatorio 50 c/ Coluna **IBIZA**

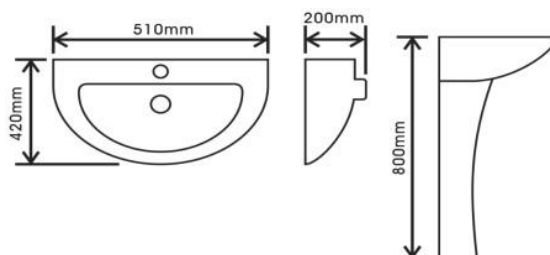

CODIGO	€
15500401	48,00

Sanita Simples descarga c/ tampo **IBIZA**



CODIGO	€
15500221*	55,00
15500201#	55,00

* Descarga Parede
Descarga Chão